

I enlarged view

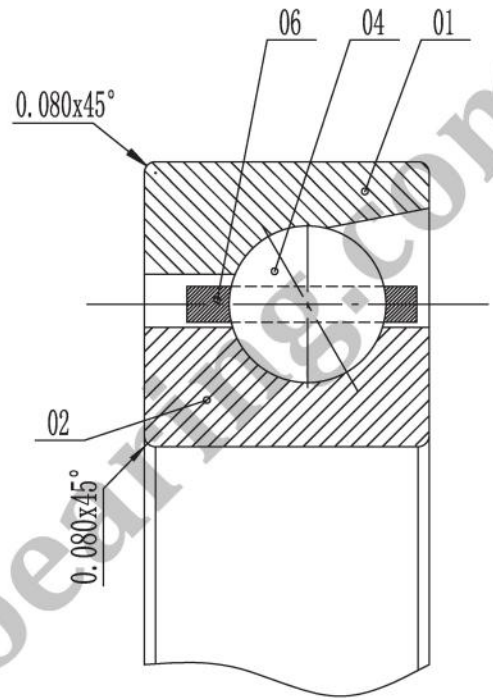

KAYDON THIN SECTION BEARING

Formal drawing of NG300ARO will be submitted after contact with:  
[sales@jcb-bearing.com](mailto:sales@jcb-bearing.com) or [sales@thinsectionbearings.com](mailto:sales@thinsectionbearings.com)

06	cage		Brass		
04	steel ball		AISI 52100 Steel		
02	inner ring	1	AISI 52100 Steel		
01	outer ring	1	AISI 52100 Steel		

No.	designation	qty	material	unit	total	remark
				weight (lbs)		

Luoyang JCB Bearing Technology Co., Ltd  
 Contact information  
 Company Address : No.285 Fenghua road, Luoyang, Henan,China.  
 Postal code : 471000  
 Phone : 0086-379-68611678 Fax : 0086-379-68611679  
 E-mail: [sales@jcb-bearing.com](mailto:sales@jcb-bearing.com)  
 Reserved E-mail: [sales@thinsectionbearings.com](mailto:sales@thinsectionbearings.com)  
 Website: <http://www.jcb-bearing.com>  
<https://www.thinsectionbearings.com>

NG300ARO

weight(lbs)

22.50

total page 1

page 1